

DESSINS TECHNIQUES

MISE EN PLACE – MONTANTS ALU AVEC EMBASES
MONTAGE DU VERRE À EXTÉRIEUR

ANGLE SORTANT

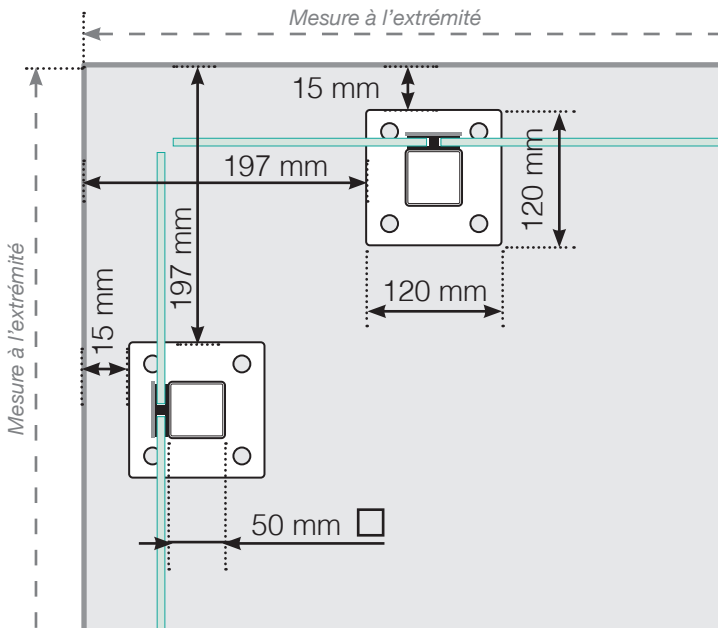

ANGLE SORTANT $\neq 90^\circ$

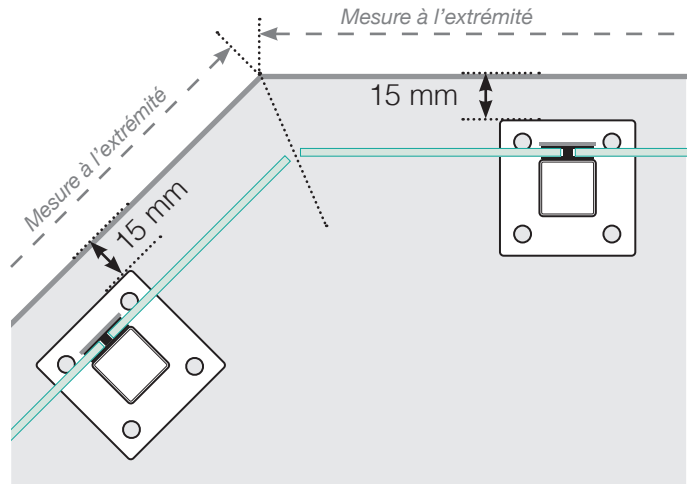

ANGLE RENTRANT $\neq 90^\circ$

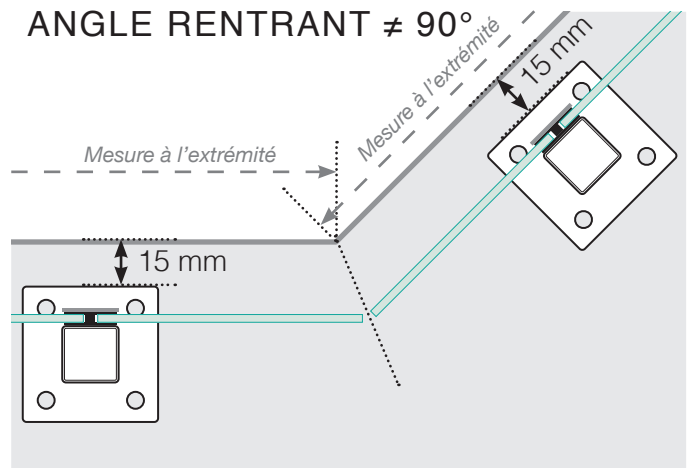

ANGLE RENTRANT

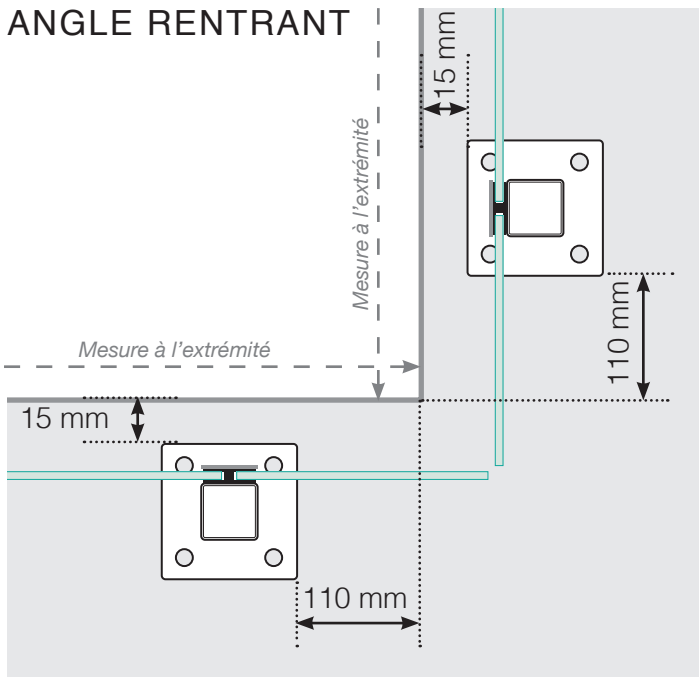

POTEAU DE FIN

Libre

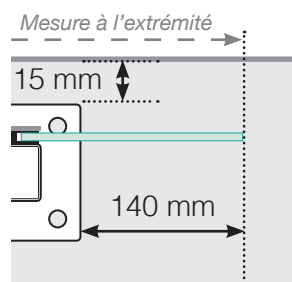

Libre Fixé au mur

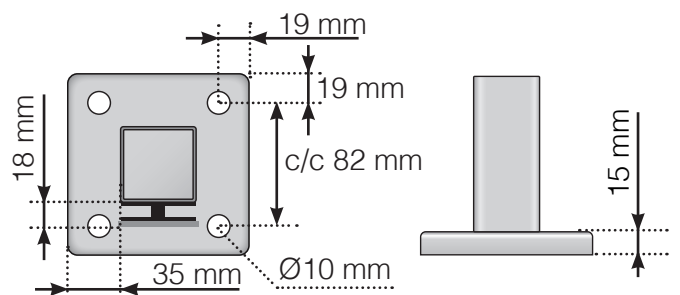
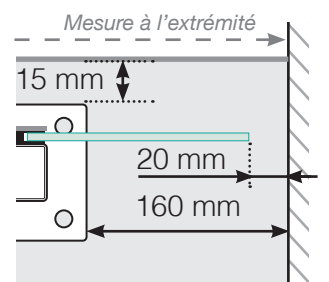

Veuillez noter que les dessins ne sont pas à l'échelle.

© Räckesbutiken Sweden AB - www.maisondugarde-corps.fr

01/03/21 v.1.0



MAISONDUGARDE-CORPS.FR